

**Data sheet | Item number: 788-304**

Relay module; Nominal input voltage: 24 VDC; 1 changeover contact;  
Limiting continuous current: 16 A; Red status indicator; Module width: 15  
mm; 2,50 mm<sup>2</sup>; gray

[www.wago.com/788-304](http://www.wago.com/788-304)

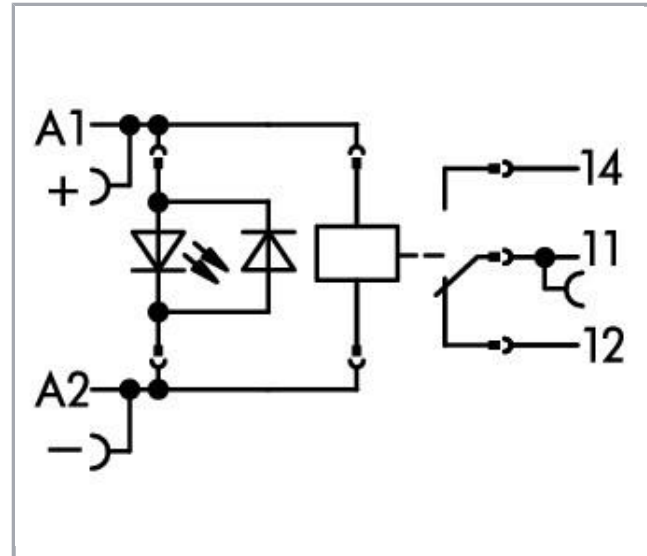
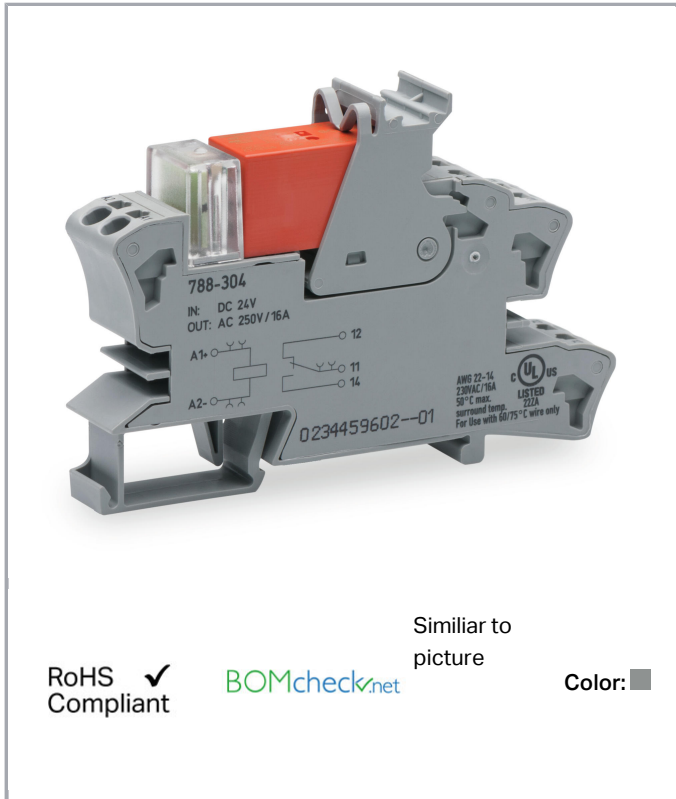

Similar to  
picture

RoHS  
Compliant ✓

[BOMcheck.net](http://BOMcheck.net)

Color: ■

Subject to changes. Please also observe the further product documentation!

WAGO Kontakttechnik GmbH & Co. KG  
Hansastr. 27  
32423 Minden  
Phone: +49571 887-0 | Fax: +49571 887-169  
Email: [info.de@wago.com](mailto:info.de@wago.com) | Web: [www.wago.com](http://www.wago.com)

Do you have any questions about our products?  
We are always happy to take your call at +49 (571) 887-44222.

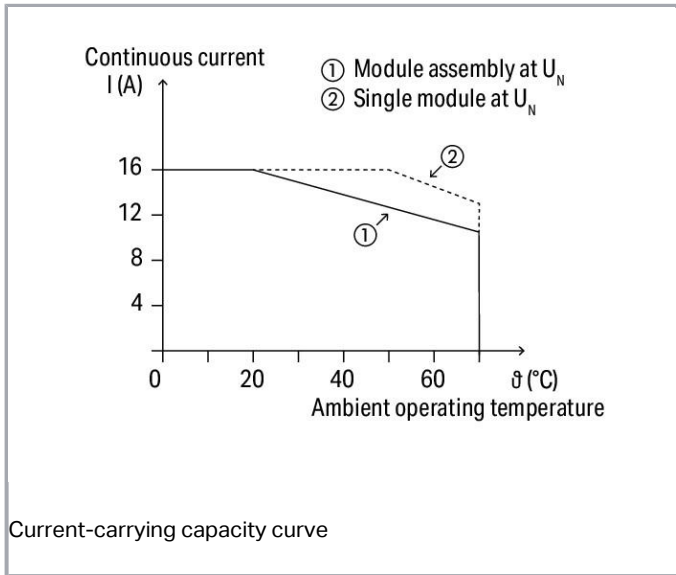

Current-carrying capacity curve

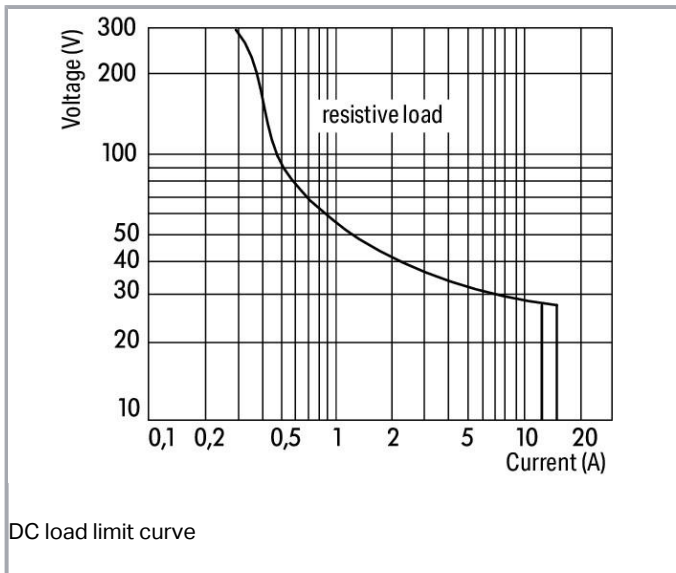
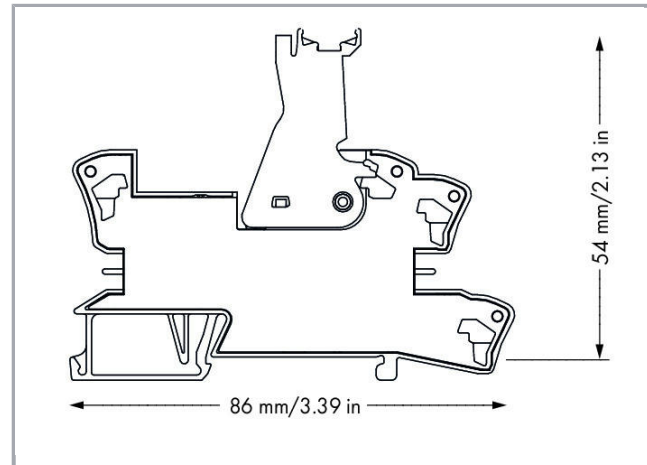

DC load limit curve

## Item description

### Note:

- Reinforced insulation between coil and contacts
- A separator plate (e.g., 209-191) must be used for voltages greater than 250 V between adjacent relay modules and for compliance with the reinforced insulation requirements.
- To protect the relay coils and contacts, inductive loads must be dampened with an effective protection circuit.

Subject to changes. Please also observe the further product documentation!

WAGO Kontakttechnik GmbH & Co. KG

Hansastr. 27

32423 Minden

Phone: +49571 887-0 | Fax: +49571 887-169

Email: [info.de@wago.com](mailto:info.de@wago.com) | Web: [www.wago.com](http://www.wago.com)

Do you have any questions about our products?

We are always happy to take your call at +49 (571) 887-44222.



## Data

### Technical Data

#### Control circuit

Nominal input voltage $U_N$	DC 24 V
Input voltage range	$\pm 10\%$
Nominal input current at $U_N$	19 mA

#### Load circuit:

Number of changeover/switchover contacts	1
Contact material (relay)	AgNi 90/10
Limiting continuous current	16 A
Inrush current (resistive) (max.)	(AC) 30 A / 4 s
Switching voltage (max.)	AC 250 V
Switching power (resistive) (max.)	AC 4000 VA; DC (see load limit curve)
Switching capacity	AC-15: 6 A / AC 250 V; DC-13: 2 A / DC 24 V
Recommended minimum load	12 V / 10 mA
Pull-in time (typ.)	8 ms
Drop-out time (typ.)	6 ms
Bounce time (typ.)	6 ms
Electrical life (NO; resistive load; 23 °C)	$30 \times 10^3$ switching operations
Mechanical life	$30 \times 10^6$ switching operations
Switching frequency with/without load (max.)	$6 \text{ min}^{-1}$ / $1200 \text{ min}^{-1}$

#### Signaling

Status indicator	Red LED
------------------	---------

#### Safety and protection:

Rated voltage	250 V
Rated surge voltage	4 kV
Pollution degree	3
Dielectric strength, control/load circuit (AC, 1 min)	5 kVrms
Dielectric strength, open contact (AC, 1 min)	1 kVrms

Subject to changes. Please also observe the further product documentation!



Protection type	IP20
-----------------	------

### Connection data

Connection technology	Push-in CAGE CLAMP®
Solid conductor	0,34 ... 2,5 mm <sup>2</sup> / 22 ... 14 AWG
Fine-stranded conductor	0,34 ... 2,5 mm <sup>2</sup> / 22 ... 14 AWG
Strip length	9 ... 10 mm / 0.35 ... 0.39 inch

### Geometrical Data

Width	15 mm / 0.591 inch
Height from upper-edge of DIN-rail	54 mm / 2.126 inch
Depth	86 mm / 3.386 inch

### Mechanical data

Mounting type	DIN-35 rail
---------------	-------------

### Material Data

Color	gray
Fire load	0.915 MJ
Weight	45.9 g

### Environmental Requirements

Surrounding air temperature (operation at $U_N$ )	-40 ... 70 °C
Surrounding air temperature (storage)	-40 ... 70 °C
Processing temperature	-25 ... +50 °C

### Standards and specifications

Standards/specifications	EN 61010-2-201; EN 61810-1; EN 61373; UL 508 (max. 10 A)
--------------------------	--

### Elementary relay

WAGO Basic Relay	788-154
------------------	---------

### Commercial data

Product Group	6 (Interface Electronics)
---------------	---------------------------

Subject to changes. Please also observe the further product documentation!

WAGO Kontakttechnik GmbH & Co. KG  
 Hansastr. 27  
 32423 Minden  
 Phone: +49571 887-0 | Fax: +49571 887-169  
 Email: [info.de@wago.com](mailto:info.de@wago.com) | Web: [www.wago.com](http://www.wago.com)

Do you have any questions about our products?  
 We are always happy to take your call at +49 (571) 887-44222.

Packaging type	BOX
Country of origin	CN
GTIN	4055143184113
Customs tariff number	85364900990

## Approvals / Certificates





### UL-Approvals

Logo	Approval	Additional Approval Text	Certificate name
	UL UL International Netherlands B.V. (ORDINARY LOCATIONS)	UL 508	E175199 Sec.6

## Counterpart

## Compatible products















### ferrule

	<b>Item no.: 216-241</b> Ferrule; Sleeve for 0.5 mm <sup>2</sup> / 20 AWG; insulated; electro-tin plated; electrolytic copper; gastight crimped; acc. to DIN 46228, Part 4/09.90; white	<a href="http://www.wago.com/216-241">www.wago.com/216-241</a>
	<b>Item no.: 216-242</b> Ferrule; Sleeve for 0.75 mm <sup>2</sup> / 18 AWG; insulated; electro-tin plated; electrolytic copper; gastight crimped; acc. to DIN 46228, Part 4/09.90; gray	<a href="http://www.wago.com/216-242">www.wago.com/216-242</a>
	<b>Item no.: 216-243</b> Ferrule; Sleeve for 1 mm <sup>2</sup> / AWG 18; insulated; electro-tin plated; electrolytic copper; gastight crimped; acc. to DIN 46228, Part 4/09.90; red	<a href="http://www.wago.com/216-243">www.wago.com/216-243</a>
	<b>Item no.: 216-244</b> Ferrule; Sleeve for 1.5 mm <sup>2</sup> / AWG 16; insulated; electro-tin plated; electrolytic copper; gastight crimped; acc. to DIN 46228, Part 4/09.90; black	<a href="http://www.wago.com/216-244">www.wago.com/216-244</a>
	<b>Item no.: 216-542</b> Twin ferrule; Sleeve for 2 x 1 mm <sup>2</sup> / AWG 2 x 18; red, insulated; 12 mm long; red	<a href="http://www.wago.com/216-542">www.wago.com/216-542</a>

### Marking accessories

	<b>Item no.: 2009-110</b> Marking strips; on reel; not stretchable; plain; snap-on type; white	<a href="http://www.wago.com/2009-110">www.wago.com/2009-110</a>
--	---	--

Subject to changes. Please also observe the further product documentation!

	<b>Item no.: 2009-115</b> WMB-Inline; for Smart Printer; 1500 pieces on roll; stretchable 5 - 5.2 mm; plain; snap-on type; white	<a href="http://www.wago.com/2009-115">www.wago.com/2009-115</a>
	<b>Item no.: 2009-115/000-002</b> WMB-Inline; for Smart Printer; 1500 pieces on roll; stretchable 5 - 5.2 mm; plain; snap-on type; yellow	<a href="http://www.wago.com/2009-115/000-002">www.wago.com/2009-115/000-002</a>
	<b>Item no.: 2009-115/000-006</b> WMB-Inline; for Smart Printer; 1500 pieces on roll; stretchable 5 - 5.2 mm; plain; snap-on type; blue	<a href="http://www.wago.com/2009-115/000-006">www.wago.com/2009-115/000-006</a>
	<b>Item no.: 2009-115/000-007</b> WMB-Inline; for Smart Printer; 1500 pieces on roll; stretchable 5 - 5.2 mm; plain; snap-on type; gray	<a href="http://www.wago.com/2009-115/000-007">www.wago.com/2009-115/000-007</a>
	<b>Item no.: 2009-115/000-012</b> WMB-Inline; for Smart Printer; 1500 pieces on roll; stretchable 5 - 5.2 mm; plain; snap-on type; orange	<a href="http://www.wago.com/2009-115/000-012">www.wago.com/2009-115/000-012</a>
	<b>Item no.: 2009-115/000-017</b> WMB-Inline; for Smart Printer; 1500 pieces on roll; stretchable 5 - 5.2 mm; plain; snap-on type; light green	<a href="http://www.wago.com/2009-115/000-017">www.wago.com/2009-115/000-017</a>
	<b>Item no.: 2009-115/000-023</b> WMB-Inline; for Smart Printer; 1500 pieces on roll; stretchable 5 - 5.2 mm; plain; snap-on type; green	<a href="http://www.wago.com/2009-115/000-023">www.wago.com/2009-115/000-023</a>
	<b>Item no.: 209-128</b> Adaptor; gray	<a href="http://www.wago.com/209-128">www.wago.com/209-128</a>
	<b>Item no.: 209-183</b> Marker card; white	<a href="http://www.wago.com/209-183">www.wago.com/209-183</a>
	<b>Item no.: 210-110</b> Fiber-tip pen	<a href="http://www.wago.com/210-110">www.wago.com/210-110</a>
	<b>Item no.: 249-105</b> Group marker carrier; gray	<a href="http://www.wago.com/249-105">www.wago.com/249-105</a>
	<b>Item no.: 793-501</b> WMB marking card; as card; not stretchable; plain; snap-on type; white	<a href="http://www.wago.com/793-501">www.wago.com/793-501</a>
	<b>Item no.: 793-501/000-002</b> WMB marking card; as card; not stretchable; plain; snap-on type; yellow	<a href="http://www.wago.com/793-501/000-002">www.wago.com/793-501/000-002</a>
	<b>Item no.: 793-501/000-005</b> WMB marking card; as card; not stretchable; plain; snap-on type; red	<a href="http://www.wago.com/793-501/000-005">www.wago.com/793-501/000-005</a>
	<b>Item no.: 793-501/000-006</b> WMB marking card; as card; not stretchable; plain; snap-on type; blue	<a href="http://www.wago.com/793-501/000-006">www.wago.com/793-501/000-006</a>

Subject to changes. Please also observe the further product documentation!



**Item no.: 793-501/000-007**  
WMB marking card; as card; not stretchable; plain; snap-on type; gray

[www.wago.com/793-501/000-007](http://www.wago.com/793-501/000-007)



**Item no.: 793-501/000-012**  
WMB marking card; as card; not stretchable; plain; snap-on type; orange

[www.wago.com/793-501/000-012](http://www.wago.com/793-501/000-012)



**Item no.: 793-501/000-017**  
WMB marking card; as card; not stretchable; plain; snap-on type; light green

[www.wago.com/793-501/000-017](http://www.wago.com/793-501/000-017)



**Item no.: 793-501/000-023**  
WMB marking card; as card; not stretchable; plain; snap-on type; green

[www.wago.com/793-501/000-023](http://www.wago.com/793-501/000-023)



**Item no.: 793-501/000-024**  
WMB marking card; as card; not stretchable; plain; snap-on type; violet

[www.wago.com/793-501/000-024](http://www.wago.com/793-501/000-024)



**Item no.: 793-502**  
WMB marking card; as card; MARKED; 1 ... 10 (10x); not stretchable; Horizontal marking; snap-on type; white

[www.wago.com/793-502](http://www.wago.com/793-502)



**Item no.: 793-502/000-002**  
WMB marking card; as card; MARKED; 1 ... 10 (10x); not stretchable; Horizontal marking; snap-on type; yellow

[www.wago.com/793-502/000-002](http://www.wago.com/793-502/000-002)



**Item no.: 793-502/000-005**  
WMB marking card; as card; MARKED; 1 ... 10 (10x); not stretchable; Horizontal marking; snap-on type; red

[www.wago.com/793-502/000-005](http://www.wago.com/793-502/000-005)



**Item no.: 793-502/000-006**  
WMB marking card; as card; MARKED; 1 ... 10 (10x); not stretchable; Horizontal marking; snap-on type; blue

[www.wago.com/793-502/000-006](http://www.wago.com/793-502/000-006)



**Item no.: 793-502/000-007**  
WMB marking card; as card; MARKED; 1 ... 10 (10x); not stretchable; Horizontal marking; snap-on type; gray

[www.wago.com/793-502/000-007](http://www.wago.com/793-502/000-007)



**Item no.: 793-502/000-012**  
WMB marking card; as card; MARKED; 1 ... 10 (10x); not stretchable; Horizontal marking; snap-on type; orange

[www.wago.com/793-502/000-012](http://www.wago.com/793-502/000-012)



**Item no.: 793-502/000-017**  
WMB marking card; as card; MARKED; 1 ... 10 (10x); not stretchable; Horizontal marking; snap-on type; light green

[www.wago.com/793-502/000-017](http://www.wago.com/793-502/000-017)



**Item no.: 793-502/000-023**  
WMB marking card; as card; MARKED; 1 ... 10 (10x); not stretchable; Horizontal marking; snap-on type; green

[www.wago.com/793-502/000-023](http://www.wago.com/793-502/000-023)

**Item no.: 793-502/000-024**  
WMB marking card; as card; MARKED; 1 ... 10 (10x); not stretchable; Horizontal marking; snap-on type;

Subject to changes. Please also observe the further product documentation!



violet

[www.wago.com/793-502/000-024](http://www.wago.com/793-502/000-024)
**Item no.: 793-503**WMB marking card; as card; MARKED; 11 ... 20 (10x); not stretchable; Horizontal marking; snap-on type; [www.wago.com/793-503](http://www.wago.com/793-503)  
white**Item no.: 793-503/000-002**WMB marking card; as card; MARKED; 11 ... 20 (10x); not stretchable; Horizontal marking; snap-on type; [www.wago.com/793-503/000-002](http://www.wago.com/793-503/000-002)  
yellow**Item no.: 793-503/000-005**WMB marking card; as card; MARKED; 11 ... 20 (10x); not stretchable; Horizontal marking; snap-on type; [www.wago.com/793-503/000-005](http://www.wago.com/793-503/000-005)  
red**Item no.: 793-503/000-006**WMB marking card; as card; MARKED; 11 ... 20 (10x); not stretchable; Horizontal marking; snap-on type; [www.wago.com/793-503/000-006](http://www.wago.com/793-503/000-006)  
blue**Item no.: 793-503/000-007**WMB marking card; as card; MARKED; 11 ... 20 (10x); not stretchable; Horizontal marking; snap-on type; [www.wago.com/793-503/000-007](http://www.wago.com/793-503/000-007)  
gray**Item no.: 793-503/000-012**WMB marking card; as card; MARKED; 11 ... 20 (10x); not stretchable; Horizontal marking; snap-on type; [www.wago.com/793-503/000-012](http://www.wago.com/793-503/000-012)  
orange**Item no.: 793-503/000-017**WMB marking card; as card; MARKED; 11 ... 20 (10x); not stretchable; Horizontal marking; snap-on type; [www.wago.com/793-503/000-017](http://www.wago.com/793-503/000-017)  
light green**Item no.: 793-503/000-023**WMB marking card; as card; MARKED; 11 ... 20 (10x); not stretchable; Horizontal marking; snap-on type; [www.wago.com/793-503/000-023](http://www.wago.com/793-503/000-023)  
green**Item no.: 793-503/000-024**WMB marking card; as card; MARKED; 11 ... 20 (10x); not stretchable; Horizontal marking; snap-on type; [www.wago.com/793-503/000-024](http://www.wago.com/793-503/000-024)  
violet**Item no.: 793-504**WMB marking card; as card; MARKED; 21 ... 30 (10x); not stretchable; Horizontal marking; snap-on type; [www.wago.com/793-504](http://www.wago.com/793-504)  
white**Item no.: 793-504/000-002**WMB marking card; as card; MARKED; 21 ... 30 (10x); not stretchable; Horizontal marking; snap-on type; [www.wago.com/793-504/000-002](http://www.wago.com/793-504/000-002)  
yellow**Item no.: 793-504/000-005**WMB marking card; as card; MARKED; 21 ... 30 (10x); not stretchable; Horizontal marking; snap-on type; [www.wago.com/793-504/000-005](http://www.wago.com/793-504/000-005)  
red**Item no.: 793-504/000-006**

WMB marking card; as card; MARKED; 21 ... 30 (10x); not stretchable; Horizontal marking; snap-on type;

Subject to changes. Please also observe the further product documentation!

WAGO Kontakttechnik GmbH &amp; Co. KG

Hansastr. 27

32423 Minden

Phone: +49571 887-0 | Fax: +49571 887-169

Email: [info.de@wago.com](mailto:info.de@wago.com) | Web: [www.wago.com](http://www.wago.com)

Do you have any questions about our products?

We are always happy to take your call at +49 (571) 887-44222.





blue

[www.wago.com/793-504/000-006](http://www.wago.com/793-504/000-006)



**Item no.: 793-504/000-012**

WMB marking card; as card; MARKED; 21 ... 30 (10x); not stretchable; Horizontal marking; snap-on type; orange

[www.wago.com/793-504/000-012](http://www.wago.com/793-504/000-012)



**Item no.: 793-504/000-017**

WMB marking card; as card; MARKED; 21 ... 30 (10x); not stretchable; Horizontal marking; snap-on type; light green

[www.wago.com/793-504/000-017](http://www.wago.com/793-504/000-017)



**Item no.: 793-504/000-023**

WMB marking card; as card; MARKED; 21 ... 30 (10x); not stretchable; Horizontal marking; snap-on type; green

[www.wago.com/793-504/000-023](http://www.wago.com/793-504/000-023)



**Item no.: 793-505**

WMB marking card; as card; MARKED; 31 ... 40 (10x); not stretchable; Horizontal marking; snap-on type; white

[www.wago.com/793-505](http://www.wago.com/793-505)



**Item no.: 793-505/000-005**

WMB marking card; as card; MARKED; 31 ... 40 (10x); not stretchable; Horizontal marking; snap-on type; red

[www.wago.com/793-505/000-005](http://www.wago.com/793-505/000-005)



**Item no.: 793-505/000-006**

WMB marking card; as card; MARKED; 31 ... 40 (10x); not stretchable; Horizontal marking; snap-on type; blue

[www.wago.com/793-505/000-006](http://www.wago.com/793-505/000-006)



**Item no.: 793-505/000-007**

WMB marking card; as card; MARKED; 31 ... 40 (10x); not stretchable; Horizontal marking; snap-on type; gray

[www.wago.com/793-505/000-007](http://www.wago.com/793-505/000-007)



**Item no.: 793-505/000-012**

WMB marking card; as card; MARKED; 31 ... 40 (10x); not stretchable; Horizontal marking; snap-on type; orange

[www.wago.com/793-505/000-012](http://www.wago.com/793-505/000-012)



**Item no.: 793-506**

WMB marking card; as card; MARKED; 41 ... 50 (10x); not stretchable; Horizontal marking; snap-on type; white

[www.wago.com/793-506](http://www.wago.com/793-506)



**Item no.: 793-506/000-005**

WMB marking card; as card; MARKED; 41 ... 50 (10x); not stretchable; Horizontal marking; snap-on type; red

[www.wago.com/793-506/000-005](http://www.wago.com/793-506/000-005)



**Item no.: 793-506/000-006**

WMB marking card; as card; MARKED; 41 ... 50 (10x); not stretchable; Horizontal marking; snap-on type; blue

[www.wago.com/793-506/000-006](http://www.wago.com/793-506/000-006)



**Item no.: 793-506/000-012**

WMB marking card; as card; MARKED; 41 ... 50 (10x); not stretchable; Horizontal marking; snap-on type; orange

[www.wago.com/793-506/000-012](http://www.wago.com/793-506/000-012)

**Item no.: 793-506/000-017**

WMB marking card; as card; MARKED; 41 ... 50 (10x); not stretchable; Horizontal marking; snap-on type;

Subject to changes. Please also observe the further product documentation!



light green

[www.wago.com/793-506/000-017](http://www.wago.com/793-506/000-017)
**Item no.: 793-5501**

WMB marking card; as card; for terminal block width 5 - 17.5 mm; stretchable 5 - 5.2 mm; plain; snap-on type; white

[www.wago.com/793-5501](http://www.wago.com/793-5501)
**Item no.: 793-5501/000-002**

WMB marking card; as card; for terminal block width 5 - 17.5 mm; stretchable 5 - 5.2 mm; plain; snap-on type; yellow

[www.wago.com/793-5501/000-002](http://www.wago.com/793-5501/000-002)
**Item no.: 793-5501/000-005**

WMB marking card; as card; for terminal block width 5 - 17.5 mm; stretchable 5 - 5.2 mm; plain; snap-on type; red

[www.wago.com/793-5501/000-005](http://www.wago.com/793-5501/000-005)
**Item no.: 793-5501/000-006**

WMB marking card; as card; for terminal block width 5 - 17.5 mm; stretchable 5 - 5.2 mm; plain; snap-on type; blue

[www.wago.com/793-5501/000-006](http://www.wago.com/793-5501/000-006)
**Item no.: 793-5501/000-007**

WMB marking card; as card; for terminal block width 5 - 17.5 mm; stretchable 5 - 5.2 mm; plain; snap-on type; gray

[www.wago.com/793-5501/000-007](http://www.wago.com/793-5501/000-007)
**Item no.: 793-5501/000-012**

WMB marking card; as card; for terminal block width 5 - 17.5 mm; stretchable 5 - 5.2 mm; plain; snap-on type; orange

[www.wago.com/793-5501/000-012](http://www.wago.com/793-5501/000-012)
**Item no.: 793-5501/000-014**

WMB marking card; as card; for terminal block width 5 - 17.5 mm; stretchable 5 - 5.2 mm; plain; snap-on type; brown

[www.wago.com/793-5501/000-014](http://www.wago.com/793-5501/000-014)
**Item no.: 793-5501/000-017**

WMB marking card; as card; for terminal block width 5 - 17.5 mm; stretchable 5 - 5.2 mm; plain; snap-on type; green

[www.wago.com/793-5501/000-017](http://www.wago.com/793-5501/000-017)
**Item no.: 793-5501/000-023**

WMB marking card; as card; for terminal block width 5 - 17.5 mm; stretchable 5 - 5.2 mm; plain; snap-on type; light green

[www.wago.com/793-5501/000-023](http://www.wago.com/793-5501/000-023)
**Item no.: 793-5501/000-024**

WMB marking card; as card; for terminal block width 5 - 17.5 mm; stretchable 5 - 5.2 mm; plain; snap-on type; violet

[www.wago.com/793-5501/000-024](http://www.wago.com/793-5501/000-024)
**Item no.: 793-566**

WMB marking card; as card; MARKED; 1 ... 50 (2x); not stretchable; Horizontal marking; snap-on type; white

[www.wago.com/793-566](http://www.wago.com/793-566)
**Item no.: 793-566/000-002**

WMB marking card; as card; MARKED; 1 ... 50 (2x); not stretchable; Horizontal marking; snap-on type; yellow

[www.wago.com/793-566/000-002](http://www.wago.com/793-566/000-002)
**Item no.: 793-566/000-005**

WMB marking card; as card; MARKED; 1 ... 50 (2x); not stretchable; Horizontal marking; snap-on type;

Subject to changes. Please also observe the further product documentation!

WAGO Kontakttechnik GmbH &amp; Co. KG

Hansastr. 27















32423 Minden

Phone: +49571 887-0 | Fax: +49571 887-169









Email: [info.de@wago.com](mailto:info.de@wago.com) | Web: [www.wago.com](http://www.wago.com)

Do you have any questions about our products?

We are always happy to take your call at +49 (571) 887-44222.

	red	<a href="http://www.wago.com/793-566/000-005">www.wago.com/793-566/000-005</a>
	<b>Item no.: 793-566/000-006</b> WMB marking card; as card; MARKED; 1 ... 50 (2x); not stretchable; Horizontal marking; snap-on type; blue	<a href="http://www.wago.com/793-566/000-006">www.wago.com/793-566/000-006</a>
	<b>Item no.: 793-566/000-007</b> WMB marking card; as card; MARKED; 1 ... 50 (2x); not stretchable; Horizontal marking; snap-on type; gray	<a href="http://www.wago.com/793-566/000-007">www.wago.com/793-566/000-007</a>
	<b>Item no.: 793-566/000-012</b> WMB marking card; as card; MARKED; 1 ... 50 (2x); not stretchable; Horizontal marking; snap-on type; orange	<a href="http://www.wago.com/793-566/000-012">www.wago.com/793-566/000-012</a>
	<b>Item no.: 793-566/000-017</b> WMB marking card; as card; MARKED; 1 ... 50 (2x); not stretchable; Horizontal marking; snap-on type; light green	<a href="http://www.wago.com/793-566/000-017">www.wago.com/793-566/000-017</a>
	<b>Item no.: 793-566/000-023</b> WMB marking card; as card; MARKED; 1 ... 50 (2x); not stretchable; Horizontal marking; snap-on type; green	<a href="http://www.wago.com/793-566/000-023">www.wago.com/793-566/000-023</a>
	<b>Item no.: 793-566/000-024</b> WMB marking card; as card; MARKED; 1 ... 50 (2x); not stretchable; Horizontal marking; snap-on type; violet	<a href="http://www.wago.com/793-566/000-024">www.wago.com/793-566/000-024</a>
<b>General accessories</b>		
	<b>Item no.: 209-145</b> Group marker carrier; white	<a href="http://www.wago.com/209-145">www.wago.com/209-145</a>
	<b>Item no.: 209-184</b> Protection cover; transparent	<a href="http://www.wago.com/209-184">www.wago.com/209-184</a>
	<b>Item no.: 788-120</b> Accessories for relay modules; Operation status indicator: red	<a href="http://www.wago.com/788-120">www.wago.com/788-120</a>
	<b>Item no.: 788-154</b> Basic relay; Nominal input voltage: 24 VDC; 1 changeover contact; Limiting continuous current: 16 A; Module width: 13 mm; Module height: 15 mm	<a href="http://www.wago.com/788-154">www.wago.com/788-154</a>
<b>Jumper</b>		
	<b>Item no.: 788-113</b> Comb-style jumper bar; 2-way; insulated	<a href="http://www.wago.com/788-113">www.wago.com/788-113</a>
	<b>Item no.: 788-114</b> Comb-style jumper bar; 3-way; insulated	<a href="http://www.wago.com/788-114">www.wago.com/788-114</a>
	<b>Item no.: 788-115</b> Comb-style jumper bar; 4-way; insulated	<a href="http://www.wago.com/788-115">www.wago.com/788-115</a>

Subject to changes. Please also observe the further product documentation!

	<b>Item no.: 788-116</b> Comb-style jumper bar; 6-way; insulated	<a href="http://www.wago.com/788-116">www.wago.com/788-116</a>
	<b>Item no.: 788-117</b> Comb-style jumper bar; 8-way; insulated	<a href="http://www.wago.com/788-117">www.wago.com/788-117</a>
	<b>Item no.: 788-118</b> Comb-style jumper bar; 2-way (1-3); insulated	<a href="http://www.wago.com/788-118">www.wago.com/788-118</a>
	<b>Item no.: 859-402</b> Push-in type jumper bar; 2-way; Nominal current 18 A; insulated; light gray	<a href="http://www.wago.com/859-402">www.wago.com/859-402</a>
	<b>Item no.: 859-402/000-005</b> Push-in type jumper bar; 2-way; Nominal current 18 A; insulated; red	<a href="http://www.wago.com/859-402/000-005">www.wago.com/859-402/000-005</a>
	<b>Item no.: 859-402/000-006</b> Push-in type jumper bar; 2-way; Nominal current 18 A; insulated; blue	<a href="http://www.wago.com/859-402/000-006">www.wago.com/859-402/000-006</a>
	<b>Item no.: 859-402/000-029</b> Push-in type jumper bar; 2-way; Nominal current 18 A; insulated; yellow	<a href="http://www.wago.com/859-402/000-029">www.wago.com/859-402/000-029</a>
<b>tools</b>		
	<b>Item no.: 210-720</b> Operating tool; Blade: 3.5 x 0.5 mm; with a partially insulated shaft	<a href="http://www.wago.com/210-720">www.wago.com/210-720</a>

## Downloads

### Documentation

#### Bid Text

788-304 GAEB X81 - Datei	Feb 19, 2019	xml 4.7 kB	Download
-----------------------------	--------------	---------------	----------

788-304 GAEB docx - Datei	Jan 25, 2019	docx 16.7 kB	Download
------------------------------	--------------	-----------------	----------

#### Instruction Leaflet

Sockets with Elementary Relay/ SSR	V 1.0.0	pdf 2.4 MB	Download
------------------------------------	---------	---------------	----------

## CAD/CAE-Data

### CAD data

#### 2D/3D Models 788-304

Subject to changes. Please also observe the further product documentation!

[URL](#) [Download](#)

### CAE data

EPLAN Data Portal 788-304

[URL](#) [Download](#)

WSCAD Universe 788-304

[URL](#) [Download](#)

## Installation Notes

### Conductor termination

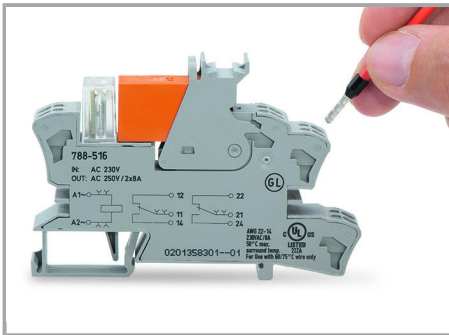

Connection of conductor

### Commoning

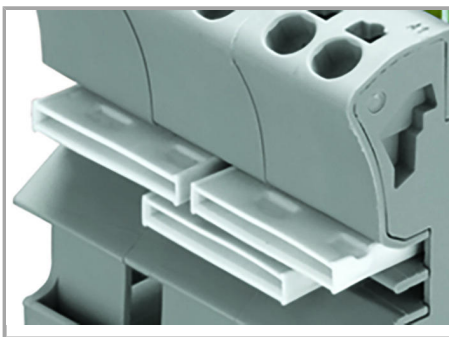

Easy commoning using adjacent jumpers

### Marking

Subject to changes. Please also observe the further product documentation!

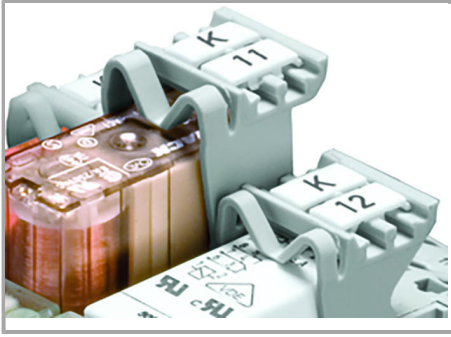

Marking using WMB Multi markers and group marker carriers

Subject to changes. Please also observe the further product documentation!